

High Bay 360° Passive Infrared Line Voltage Occupancy Sensor Control Module

MODEL: IOS-HB-U

INSTALLATION AND CONFIGURATION INSTRUCTIONS

Ratings:

Input Voltage: 120/277 VAC, 60 Hz
 Electronic Ballast (LED): 800 VA, 120 VAC; 1600 VA, 277 VAC
 Tungsten (Incandescent): 800 W, 120 VAC
 Resistive (Heater): 10 A, 120 VAC
 Motor: 1/4 HP, 120 VAC
 Adjustable Light Level – 10 fc - 150 fc
 Adjustable Time Delay - 15 sec - 30 min
 Sensitivity Adjustment - 50% or 100% (DIP switch)
 Coverage -
 Lens A: Mounting height-50 ft Field of view-360° Coverage-2800 sq. ft.
 Lens B: Mounting height-8 ft Field of view-360° Coverage-1200 sq. ft.
 Relative Humidity - 20-90%, non-condensing
 Operation Temperature: 32° - 131° F / 0° - 55° C

WARNING Risk of Fire, Electrical Shock or Personal Injury

- Turn OFF power at circuit breaker or fuse and test that the power is OFF before wiring.
- To be installed and/or used in accordance with appropriate electrical codes and regulations.
- If you are not sure about any part of these instructions, consult a qualified electrician.
- Use this device only with copper or copper clad wire.
- INDOOR USE ONLY

DESCRIPTION:

The IOS-HB-U occupancy sensor is designed for automatic lighting control in high bay applications, such as warehouses, distribution centers, gymnasiums, and areas with direct access to the lighting fixtures, specifically for indoor locations. This product contains a passive infrared sensor (PIR) and is made up of two parts: a control module and a lens.

MOUNTING THE SENSOR

The IOS-HB-U can attach to a fixture or junction box. Follow this procedure to mount the sensor to the junction box or fixture. A customer-supplied junction box with 1/2 inch knockout or fixture is needed to complete this procedure.

1. Turn off power at the circuit breaker.
2. Determine the mounting location appropriate to the control and the coverage area.
3. Punch out the cap in the 1/2 inch knockout on the junction box.
4. Remove the nut from the occupancy sensor nipple. Set aside nut for re-use.
5. Insert the nipple into the junction box or fixture.
6. Pull the wires from the nipple through the junction box and secure the connection with the nut.

INSTALLATION

NOTE: Be sure there are no objects, such as an edge of a fixture or shelving, that obstruct the sensor's line of sight.

1. Mount the sensor below the edge of the fixture, away from the fluorescent lamps so that the heat from the lamps does not affect the sensor.
2. Connect the line voltage as show in Figure 4.

NOTE: Make sure all connections are secure and the bare wire is not exposed.

3. Connect the Hot wire to the Black wire from the sensor
4. Connect the Neutral wire to the White wire from the sensor
5. Connect the Load wire to the Red wire from the sensor
6. Attach the sensor as shown in Figures 5 and 6.
7. Restore power from the circuit breaker.

INITIAL OPERATION OF SENSOR AFTER POWER UP

Upon the initial sensor power up, there is a minute warm-up period. The sensor LED flashes to indicate the sensor warm-up. Make sure there is no movement in the sensor coverage area during power up. If the sensor detects motion during the warm-up, the time delay will increase.

ADJUST THE LIGHT LEVEL

The Light Level feature enables the user to adjust the brightness requirements for the coverage area before the sensor turns the lights ON. Remove the cover from the sensor and adjust the lighting from the light level dial on the sensor (see Figure 8). You can set the dial anywhere between + or - to obtain the optimal brightness configuration for the room (see Figure 7).

LENS INSTALLATION

1. Determine which lens is required. (see Figures 1 & 2)
2. Lens simply snaps into place.

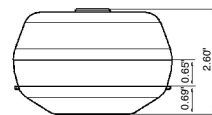
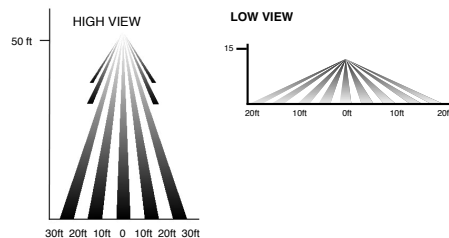

Lens A
Sensor including backbox and lens
Figure 1

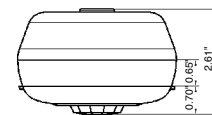

Lens B
Sensor including backbox and lens
Figure 2

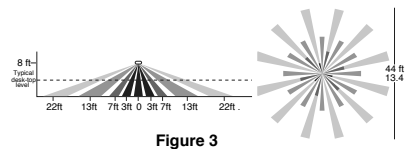

Figure 3

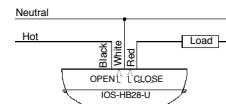

Figure 4

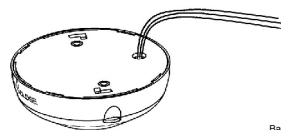

Figure 5

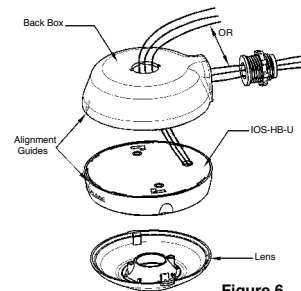
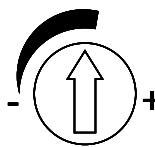

Figure 6



Light
Figure 7

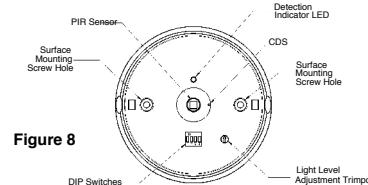

Figure 8

ADJUSTING THE SENSOR DIP SWITCH SETTINGS

The occupancy sensor features 4 DIP switches, one sensitivity setting and three time delay settings. Each setting can be set to an up position or down position that configures the DIP Switch setting to a specified sensitivity or time delay. Follow this procedure to adjust the DIP switch settings.

1. Adjust the sensitivity level DIP Switch (1). The Up position sets the sensitivity to 100%, while the down position adjusts the sensitivity level to 50%.
2. Adjust the time delay DIP switches (2-4). Refer to the table below to set a time delay.

NOTE: After the sensor detects no motion in the coverage area, it will delay a user-configured amount of time before turning lights off. See the table below to determine how to set the desired time delay for the sensor.

3. Install the front on the sensor and secure with the screws.

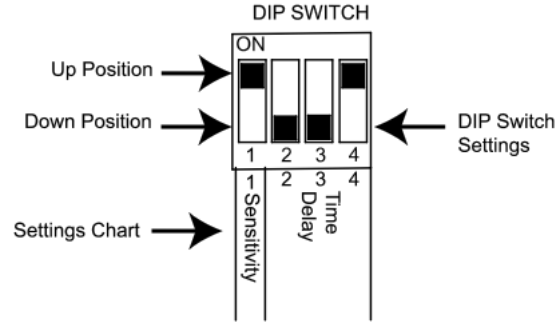

FIGURE 9. Configuring DIP Switch Settings

Time Delay Option	Slide 2 Switch Setting to	Slide 3 Switch Setting to	Slide 4 Switch Setting to
Set for 15 Seconds	Down Position	Down Position	Down Position
Set for 5 Minutes	Down Position	Down Position	Up Position
Set for 10 Minutes	Down Position	Up Position	Down Position
Set for 15 Minutes	Down Position	Up Position	Up Position
Set for 20 Minutes	Up Position	Down Position	Down Position
Set for 25 Minutes	Up Position	Down Position	Up Position
Set for 30 Minutes	Up Position	Up Position	Down Position.

TROUBLESHOOTING

LED flashes but lights do not turn ON:	<p>Make sure wiring is correct.</p> <p>Make sure that the power to the sensor has been ON continuously for 1 minute.</p> <p>Cover the light sensor lens to simulate darkness. If light turns ON adjust the light level.</p> <p>Check the light fixture.</p>
Lights will not turn OFF:	<p>Make sure other sources of infrared energy in the area, such as turbulent air from a heating or cooling supply, are not causing the sensor to detect motion. Adjust accordingly.</p> <p>Verify the time delay DIP switches are set properly.</p> <p>Check sensor wiring.</p>

LIMITED WARRANTY

Warranty service is available by either (a) returning the product to the dealer from whom the unit was purchased or (b) completing a warranty claim online at www.intermatic.com. This warranty is made by: Intermatic Incorporated, 1950 Innovation Way, Suite 300, Libertyville, IL 60048. For additional product or warranty information go to: <http://www.Intermatic.com> or call 815-675-7000.